

Sammanställning

Ritsteknik
Vy 11-20

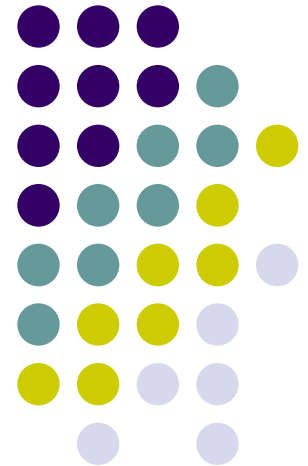

Regler

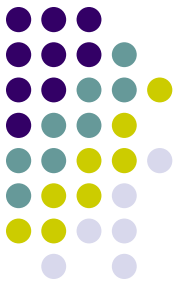

- Ritteknik bygger på regler som alla måste följa.
- Kallas för Standardisering
- I Europa följer vi samma regler
- USA har nästan samma regler, skiljer dock vid vyplacering

Regler

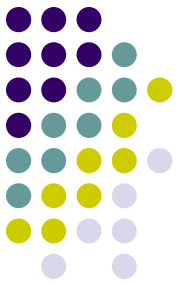

- Europa använder regler för vyplacering enligt följande:

FRAM-
VY

VÄNSTER
SIDOVY

OVAN-
VY

Övning 11: linjer som saknas

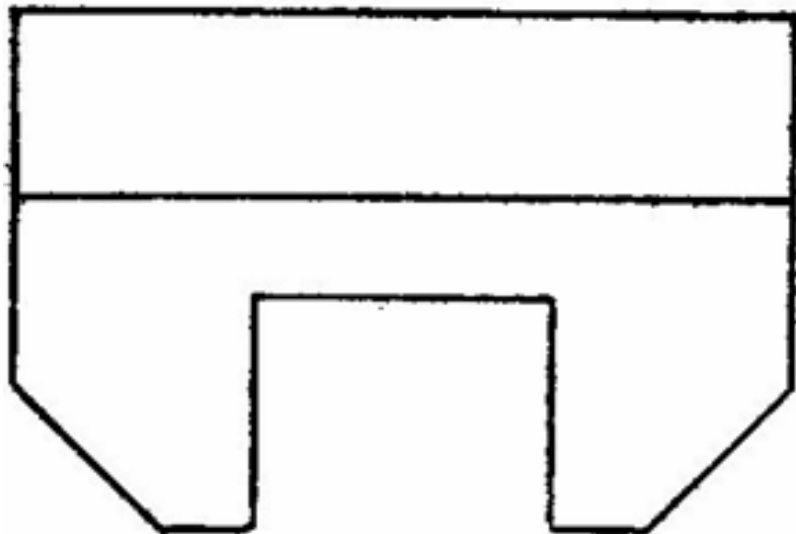
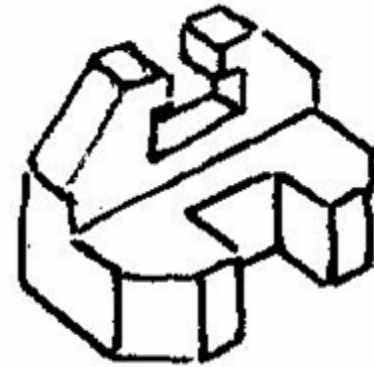
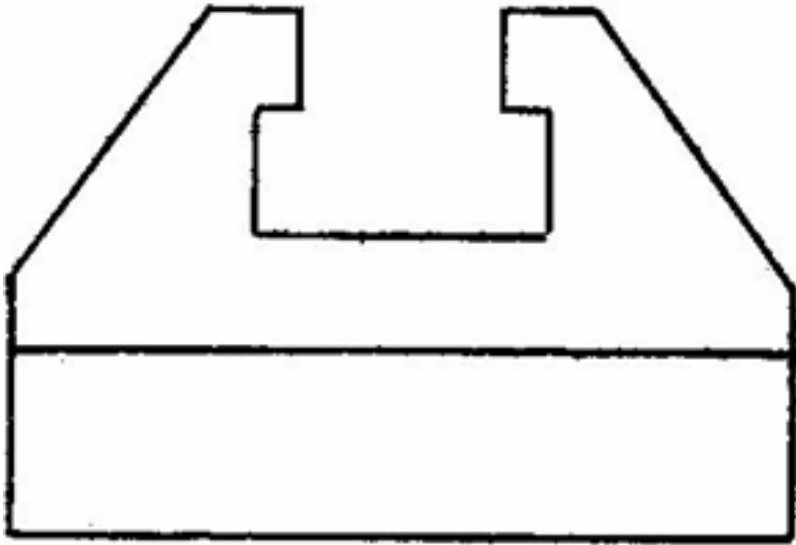
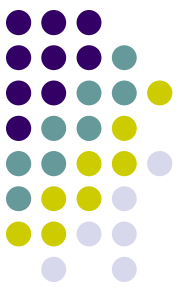

Övning 11: linjer som saknas

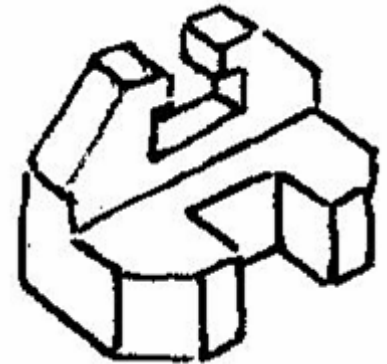
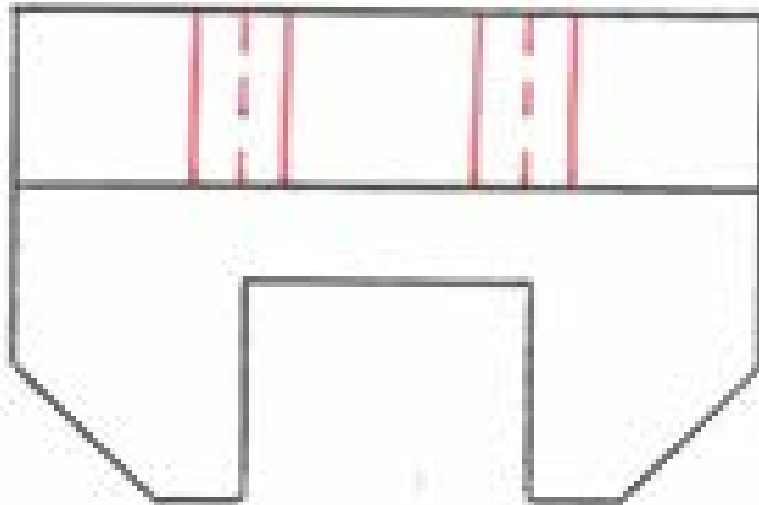
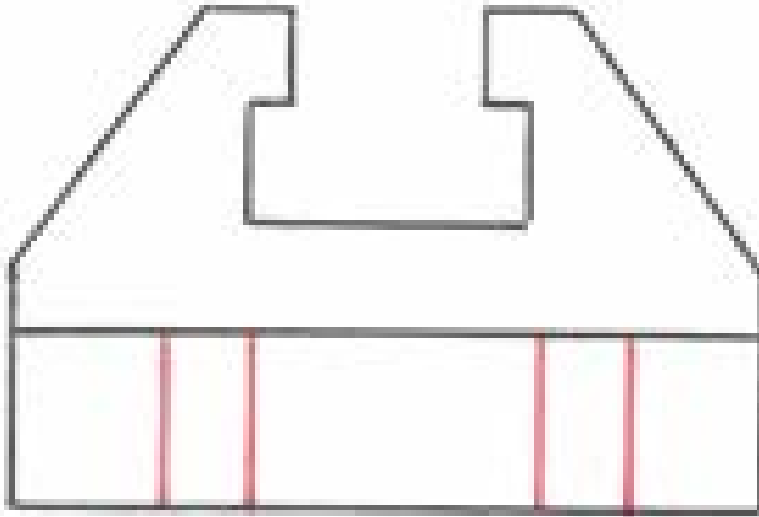
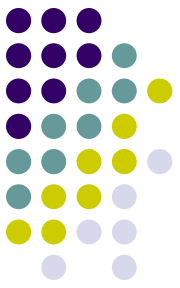

Övning 12

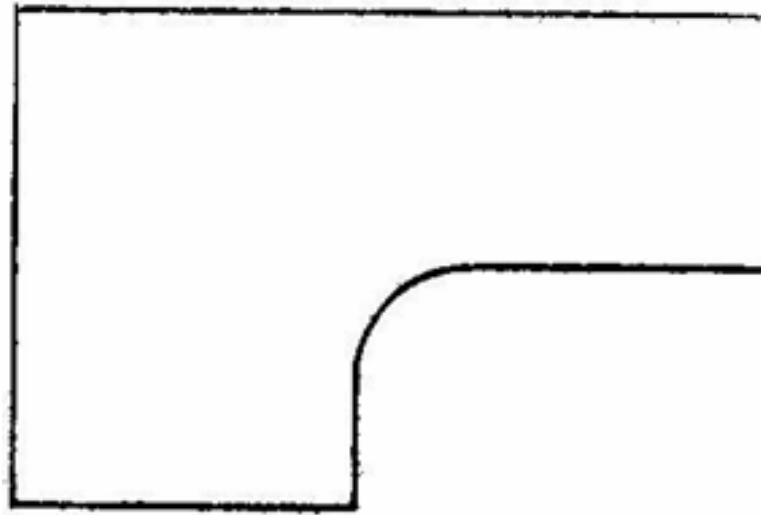
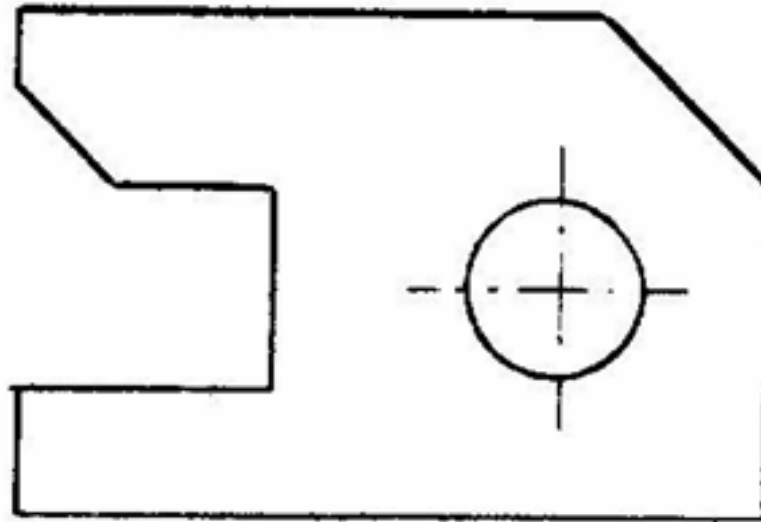
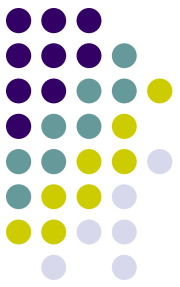

Övning 12

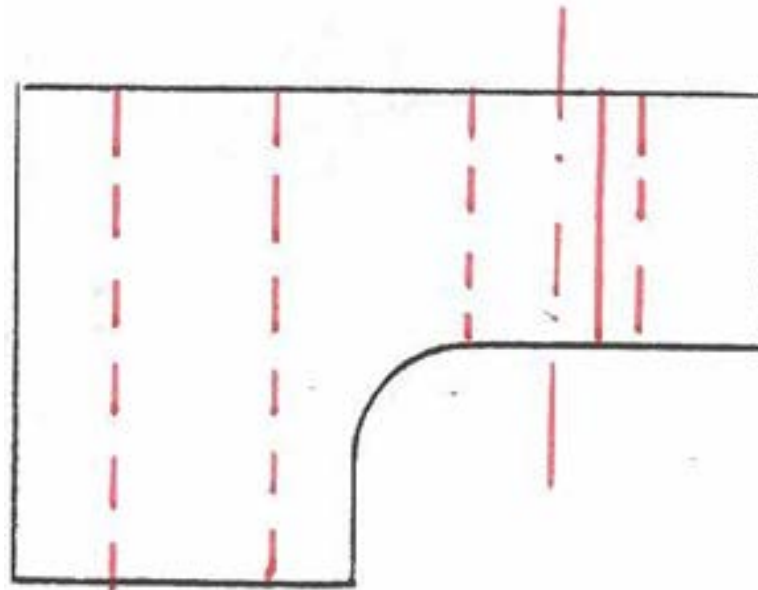
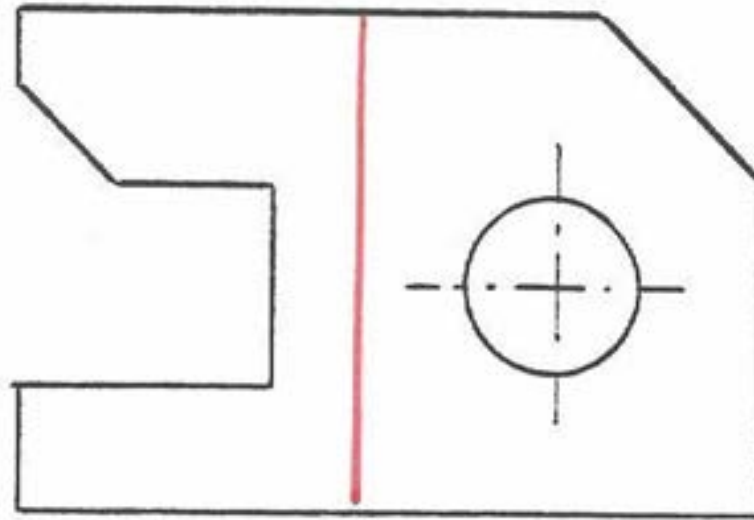
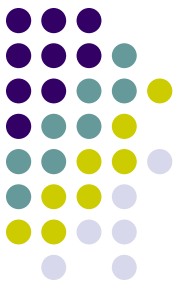

Övning 13

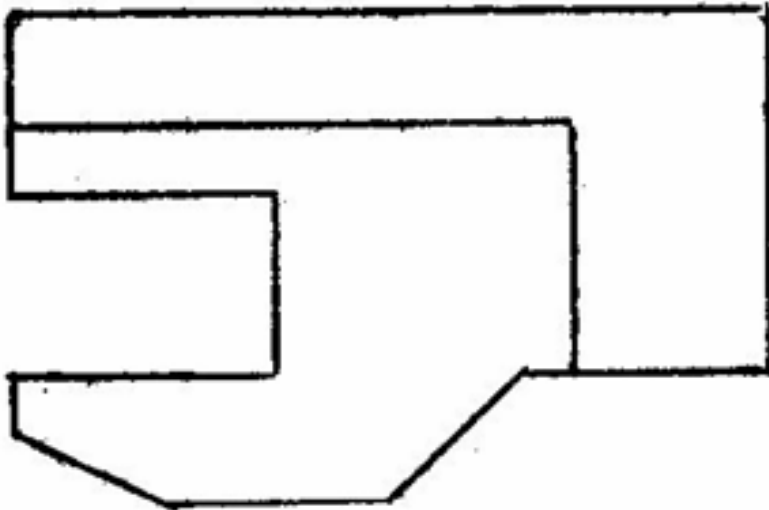
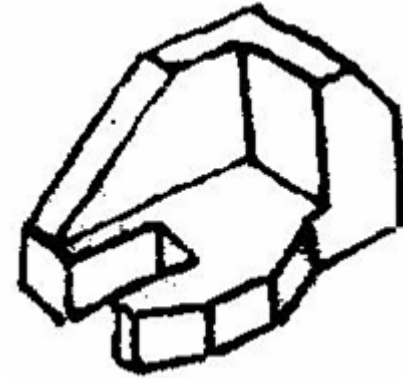
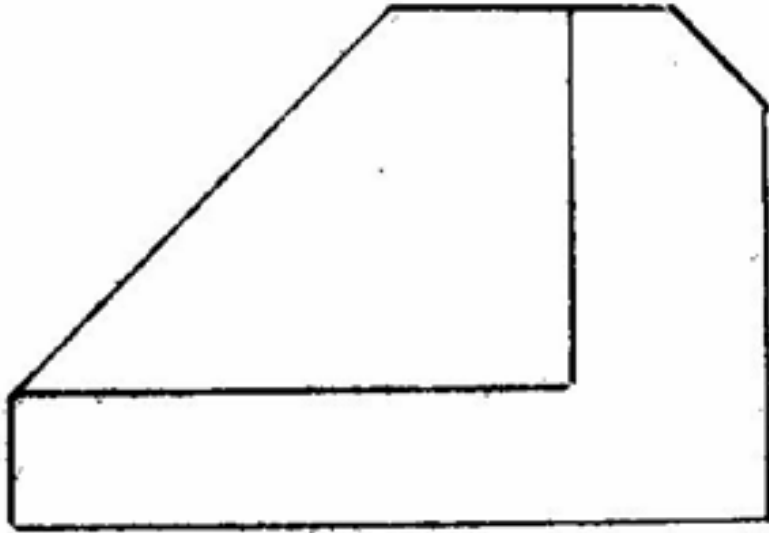
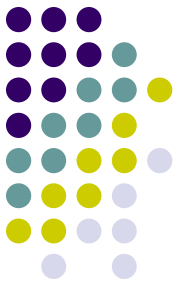

Övning 13

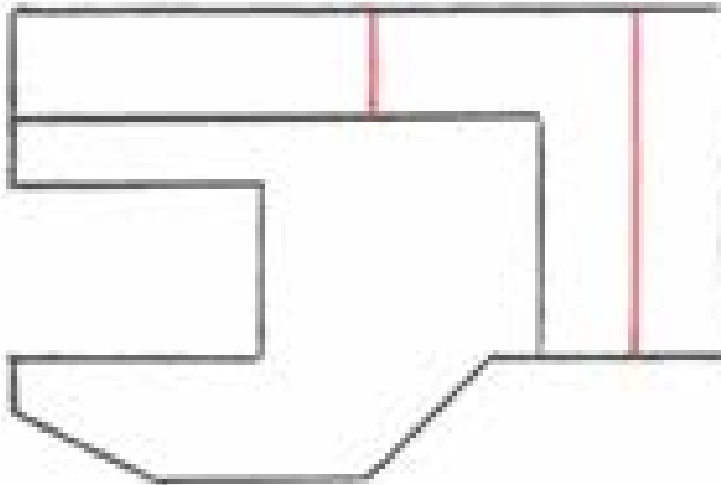
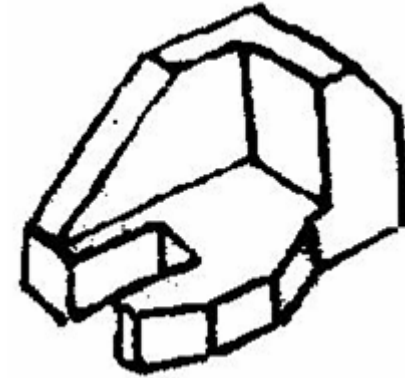
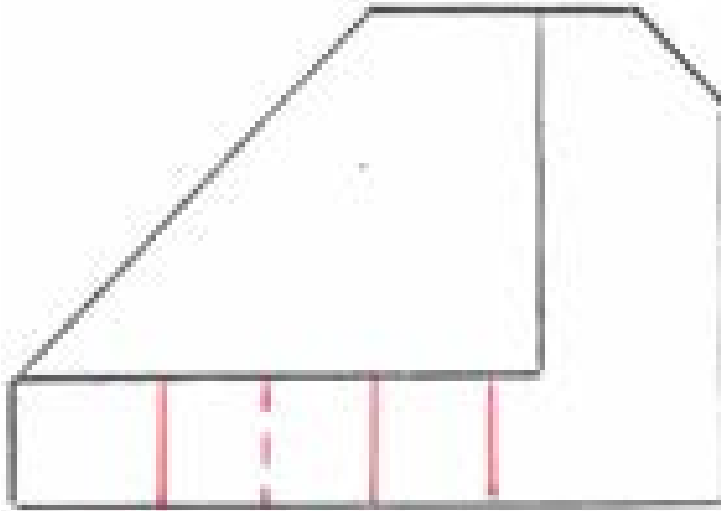
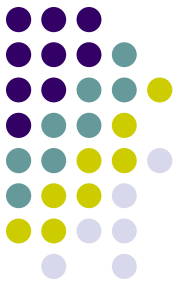

Övning 14

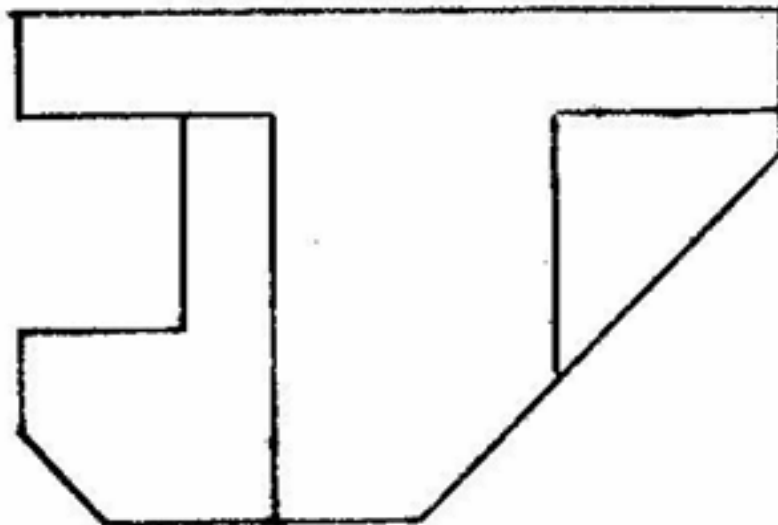
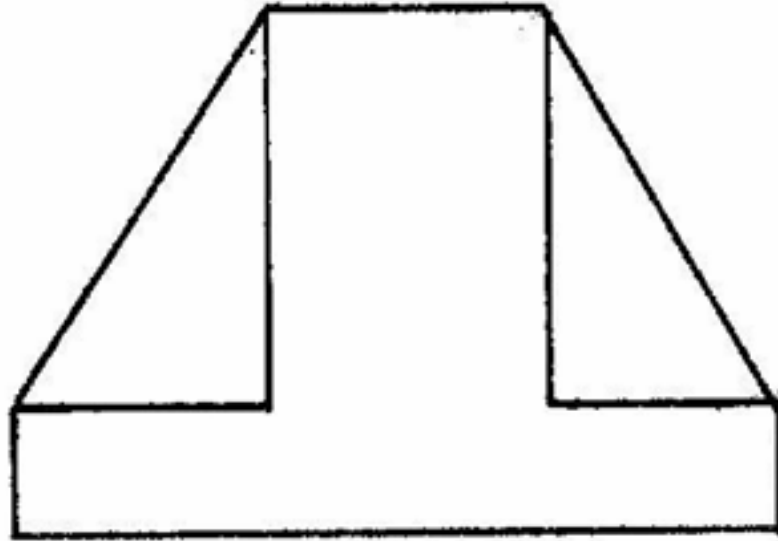
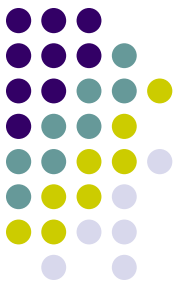

Övning 14

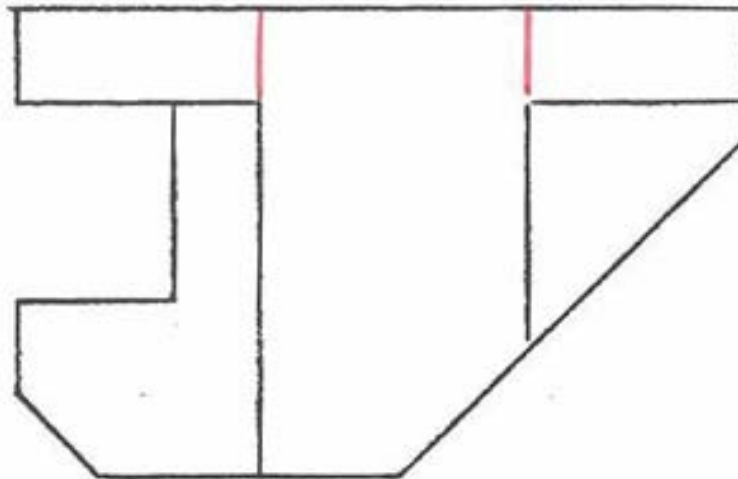
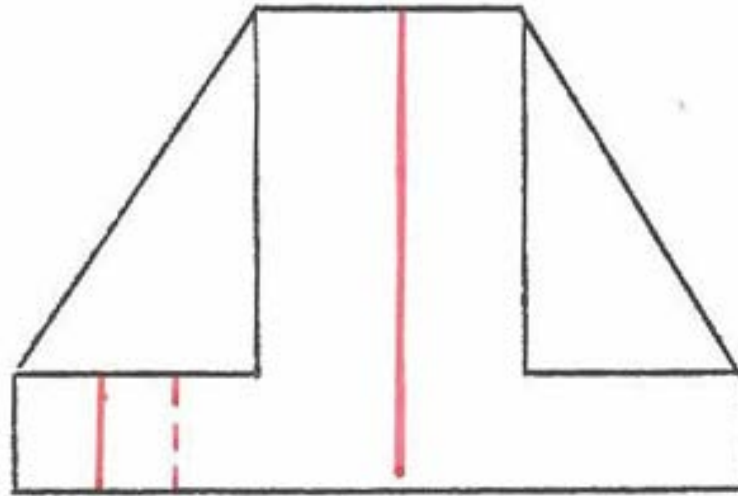
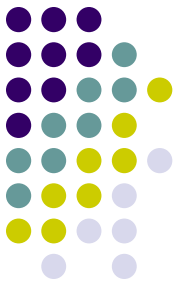

Övning 15

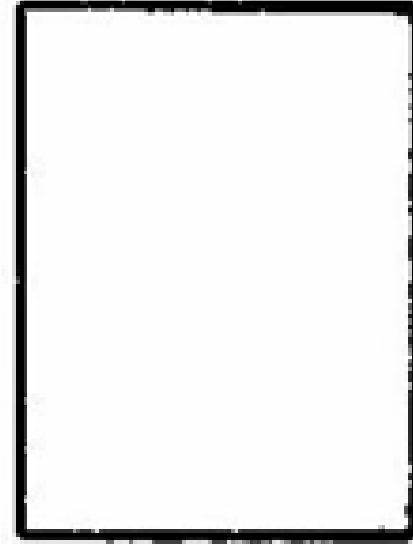
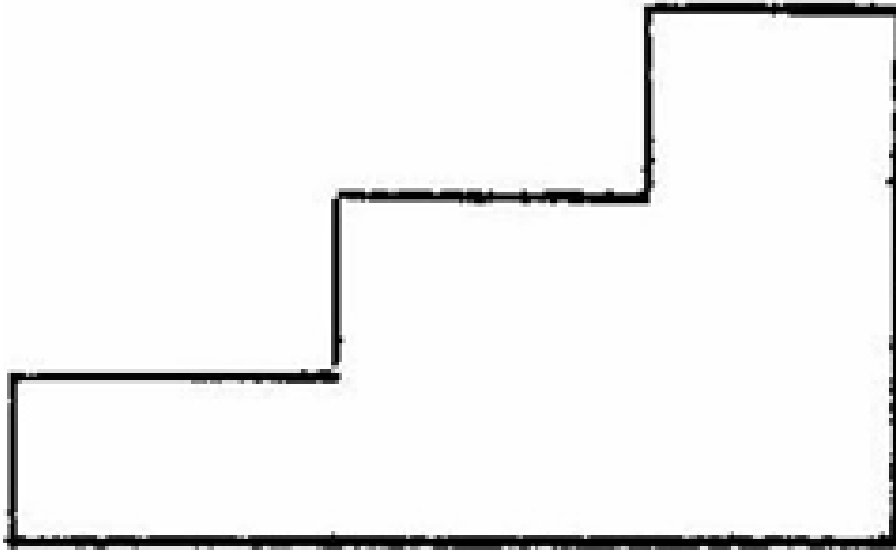
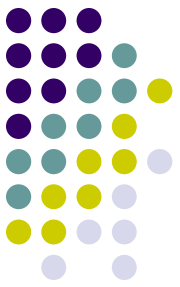

Övning 15

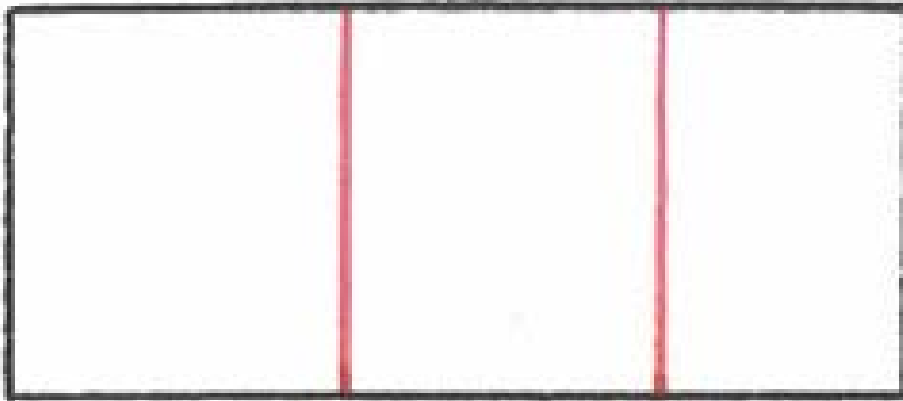
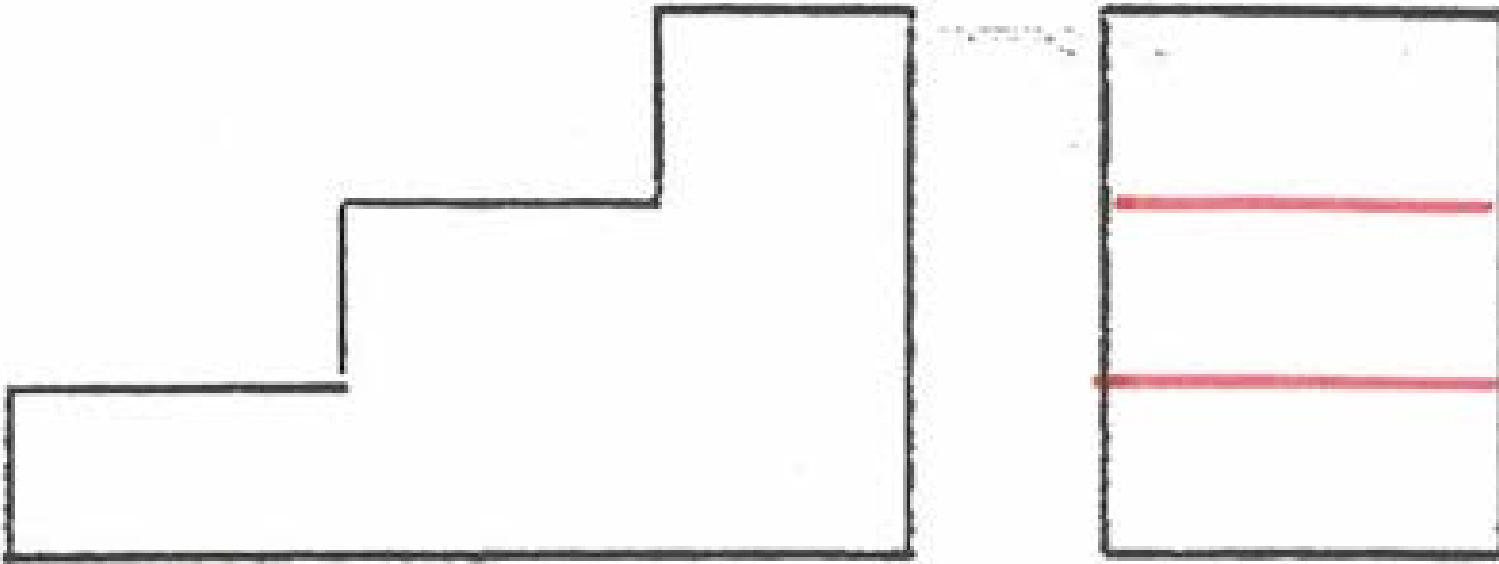
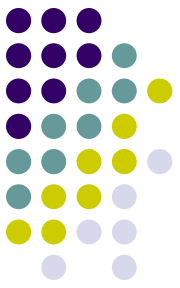

Övning 16

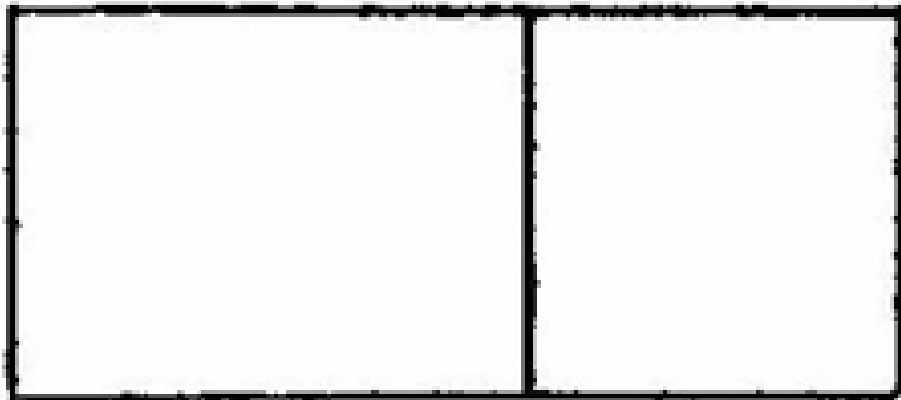
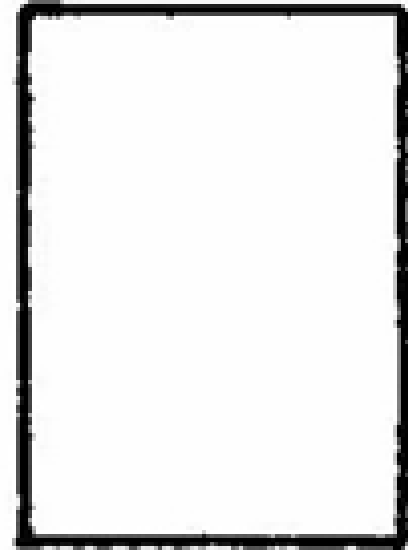
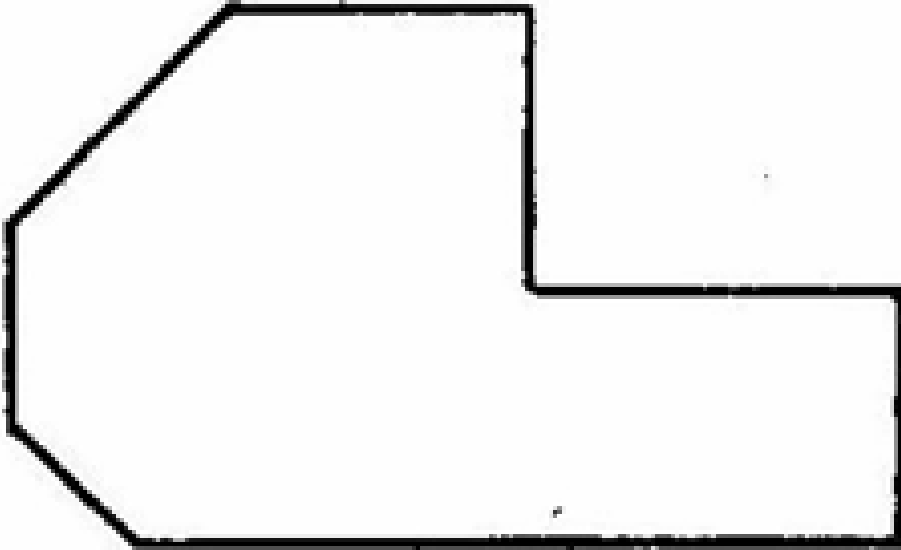
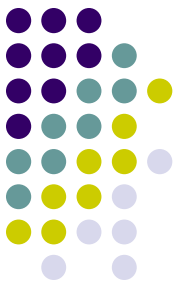

Övning 16

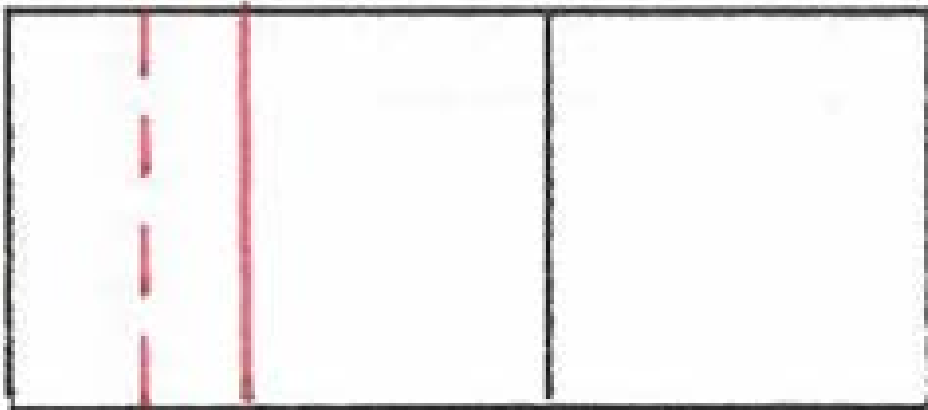
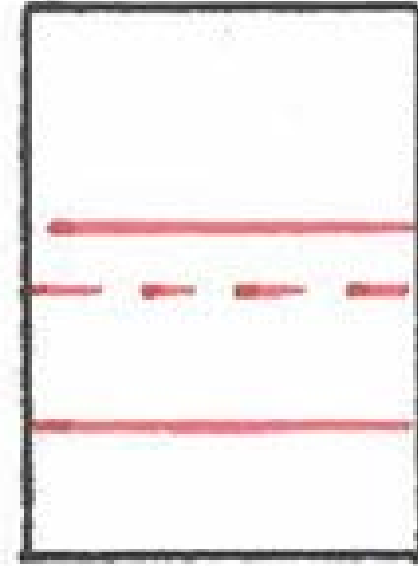
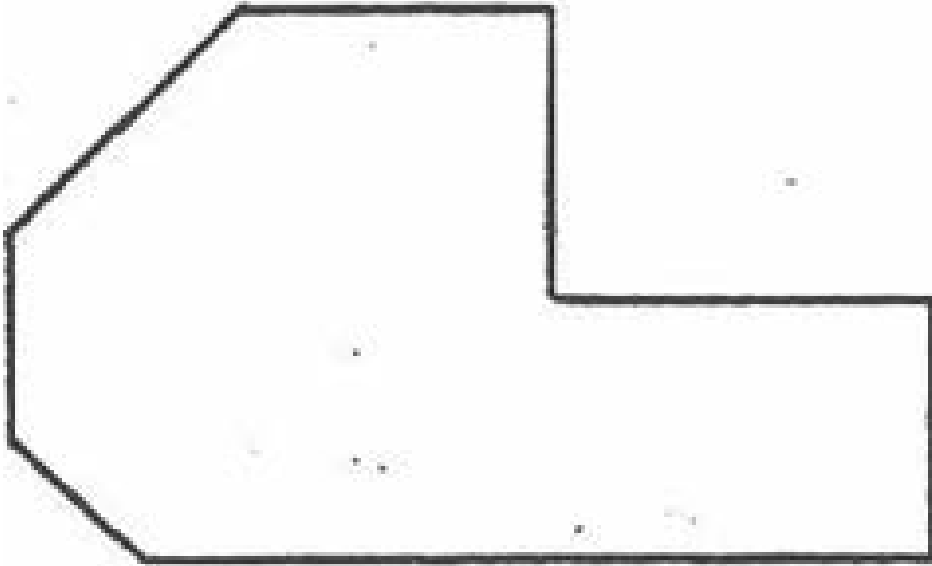
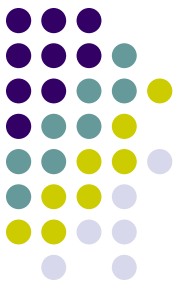

Övning 17

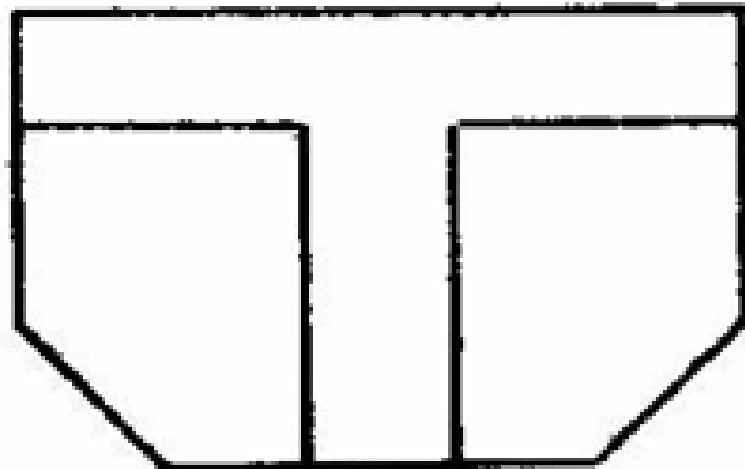
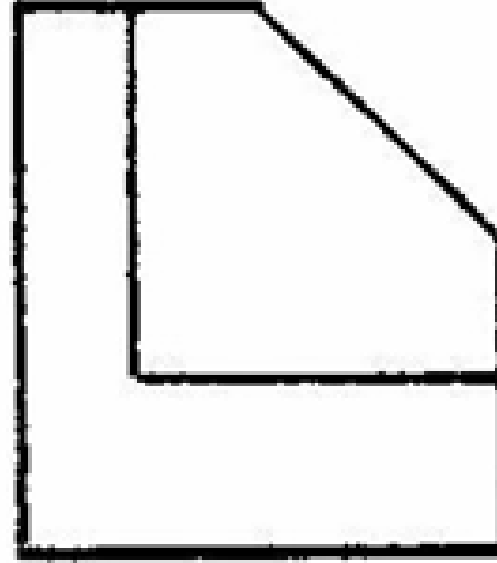
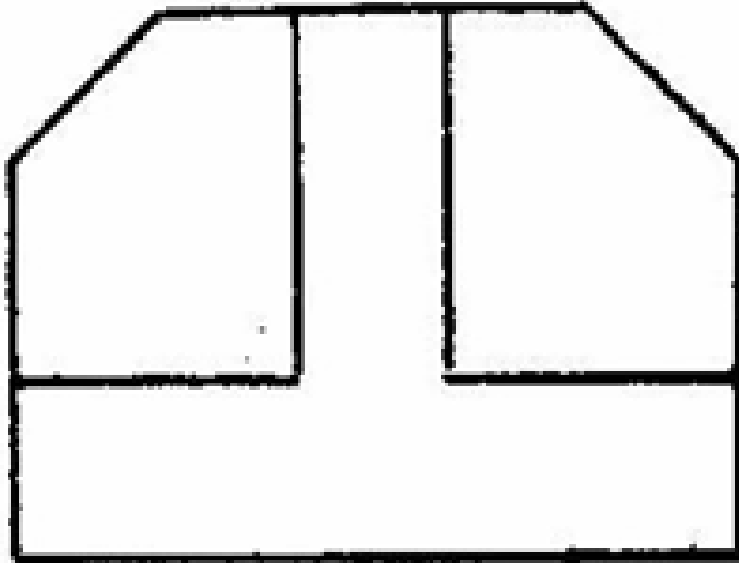
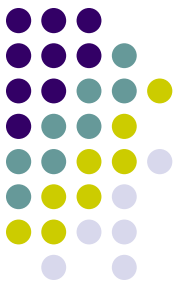

Övning 17

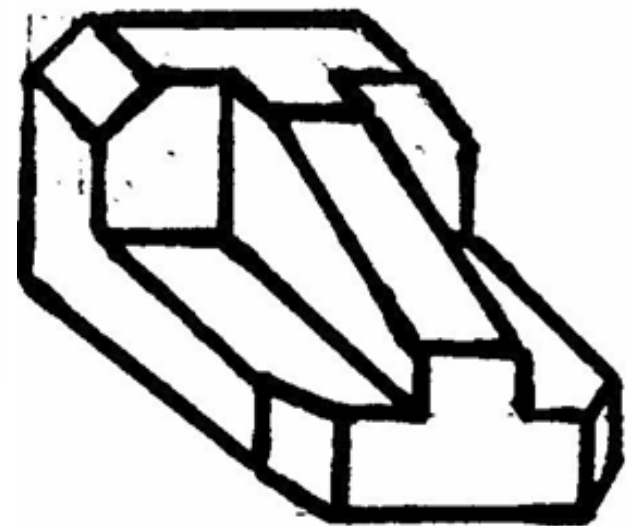
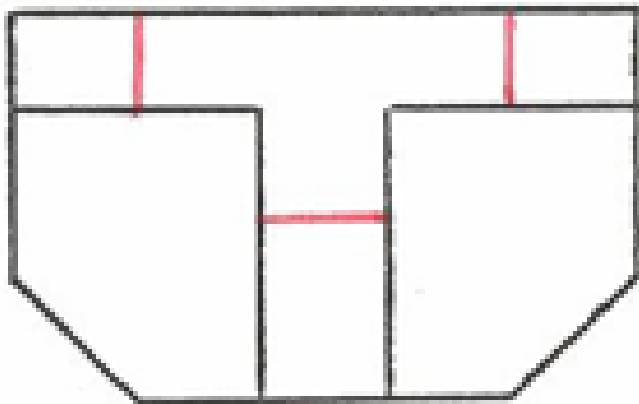
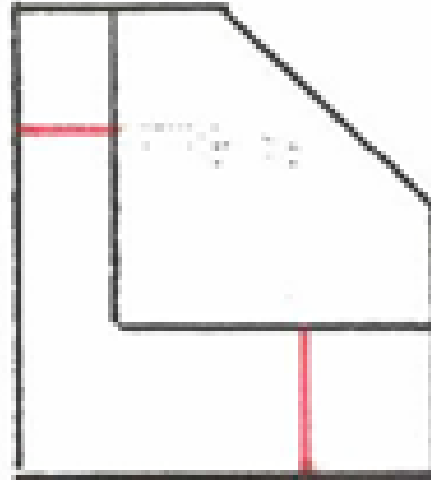
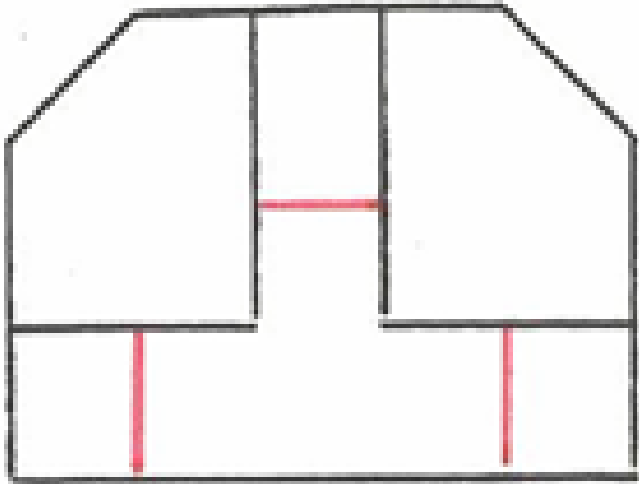
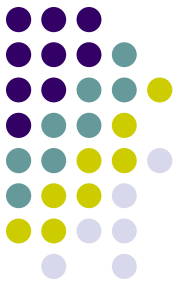

Övning 18

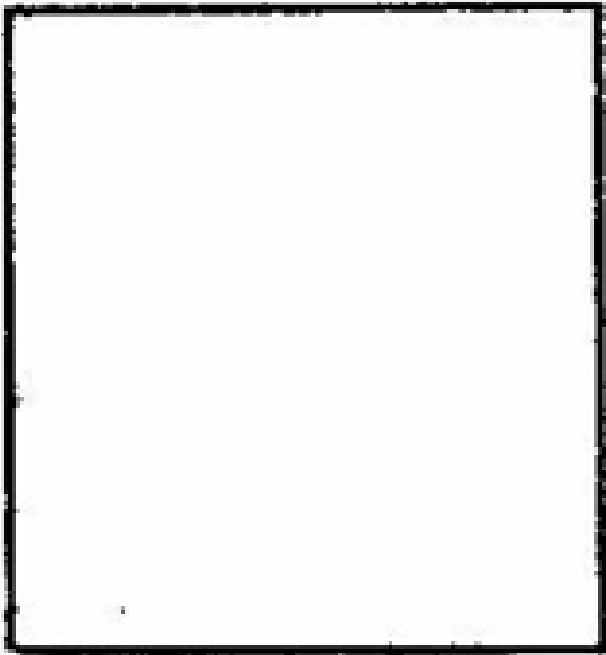
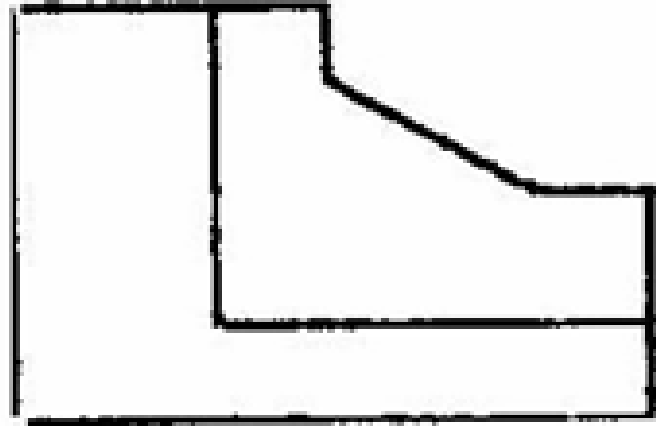
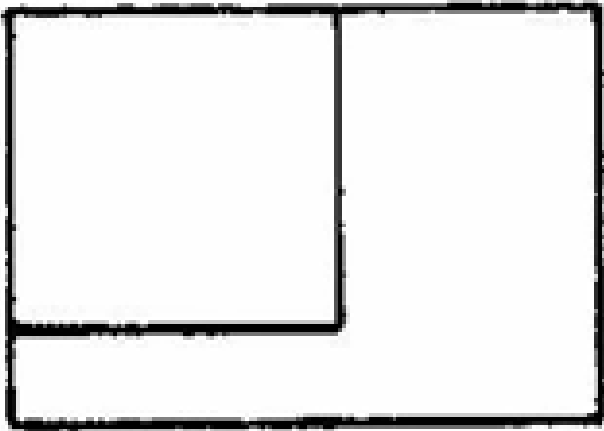
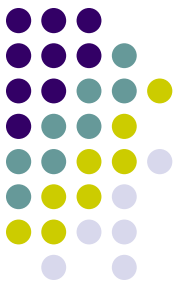

Övning 18

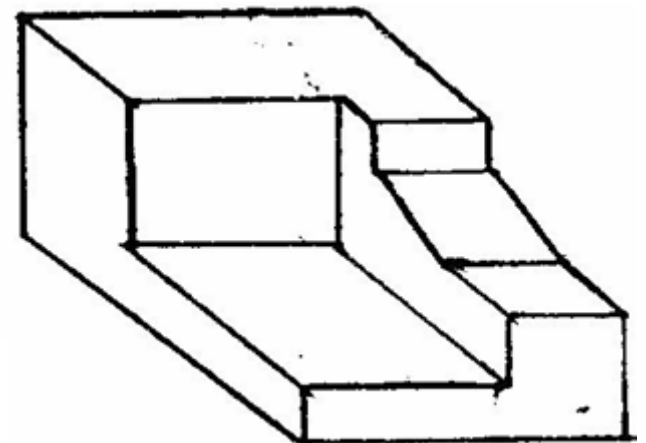
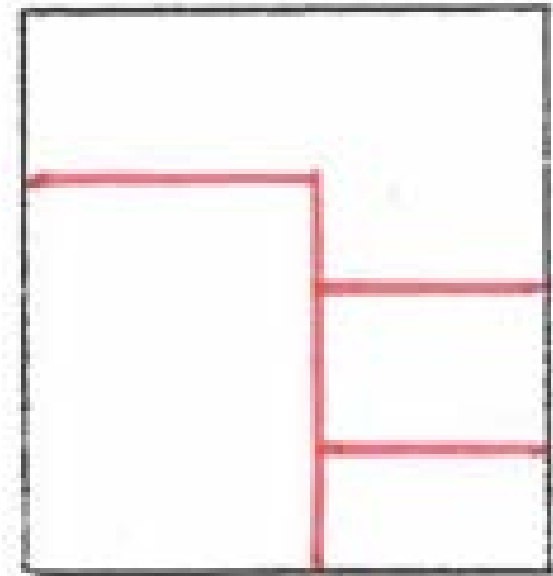
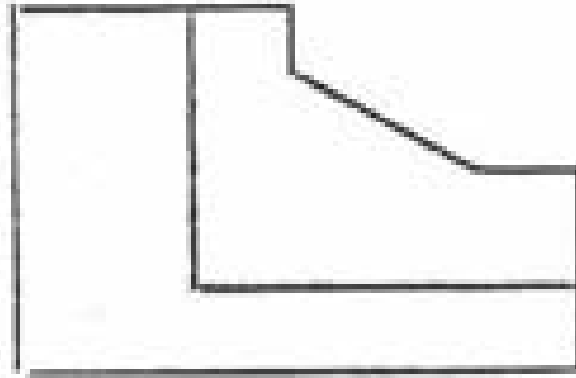
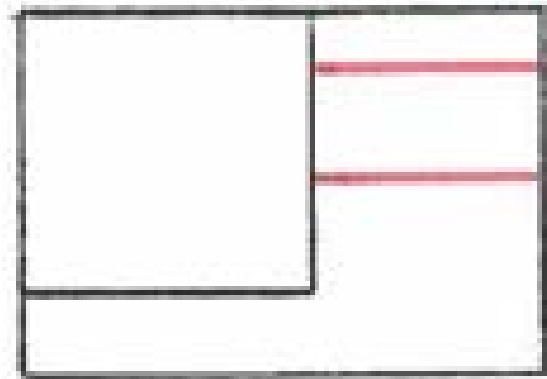
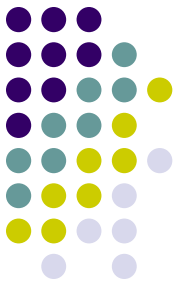

Övning 19

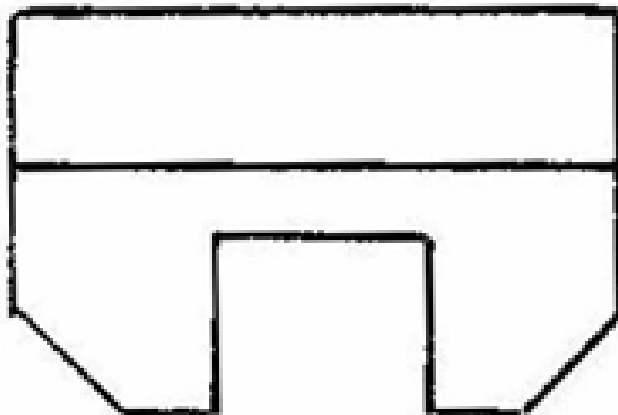
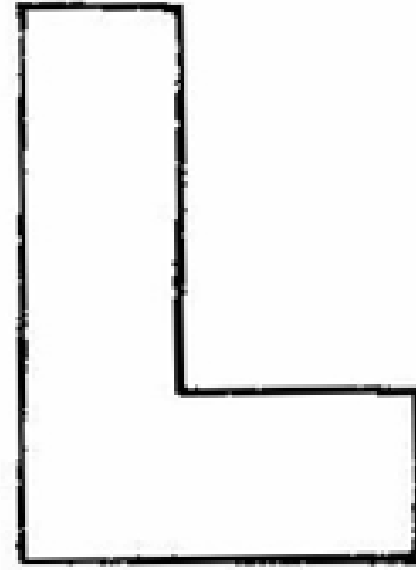
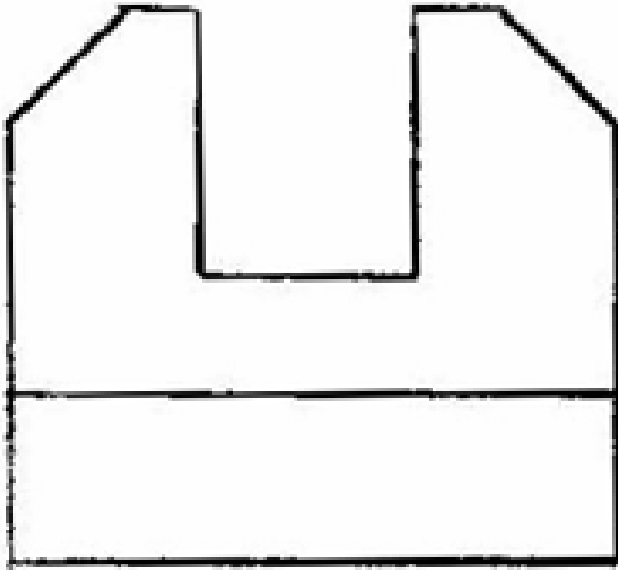
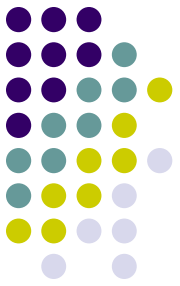

Övning 19

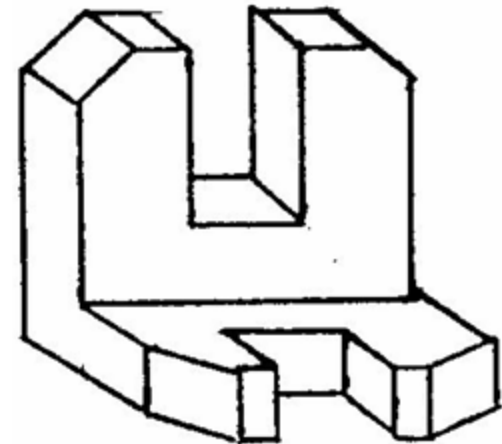
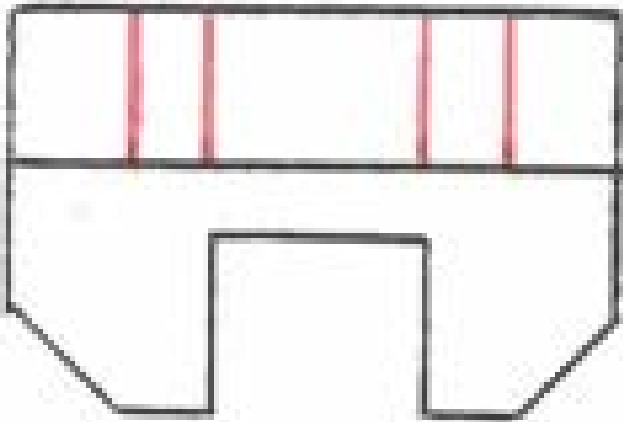
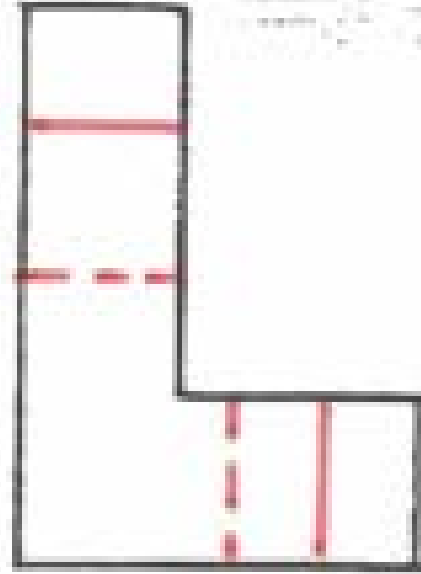
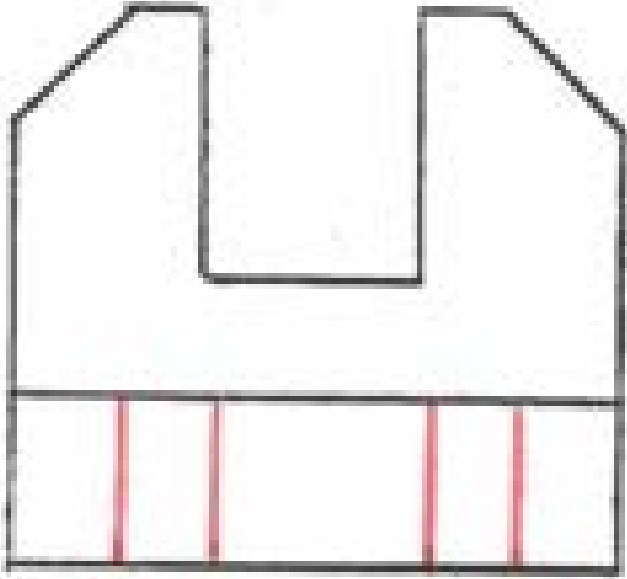
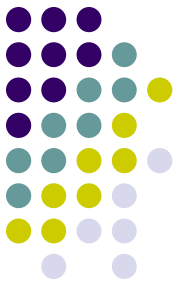

Övning 20

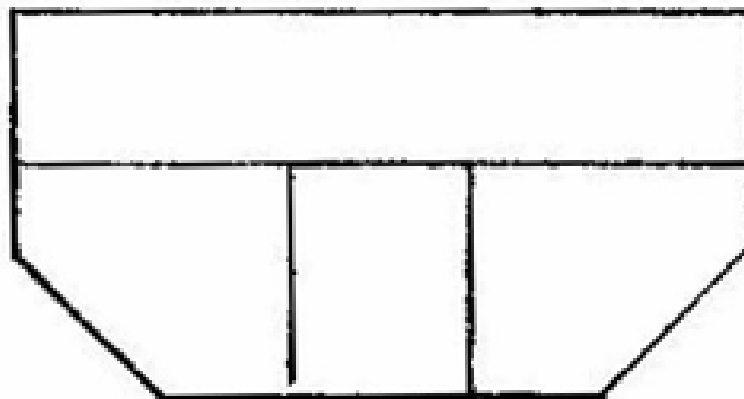
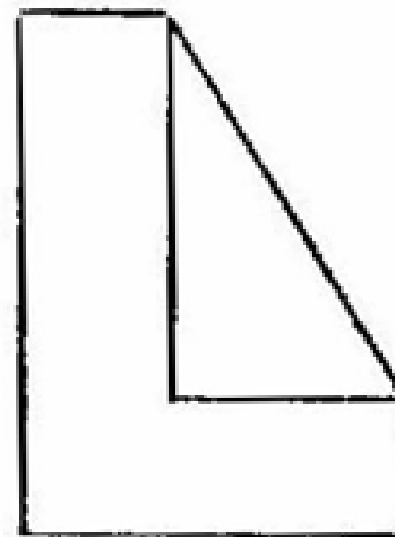
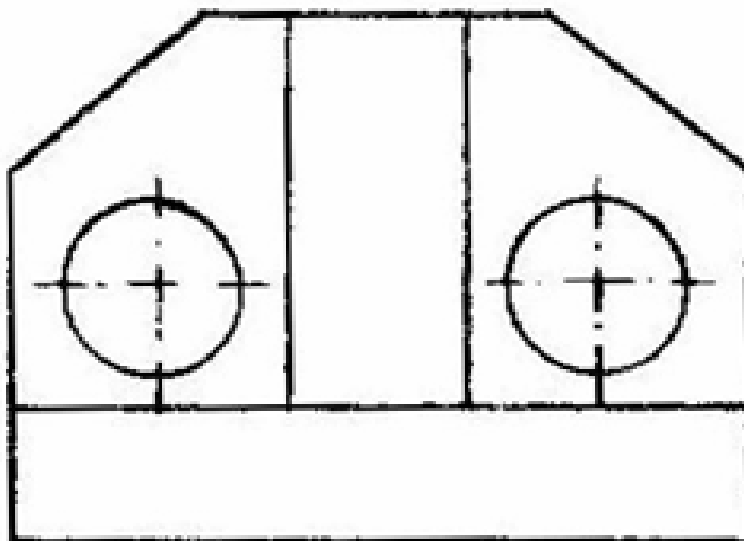

Övning 20

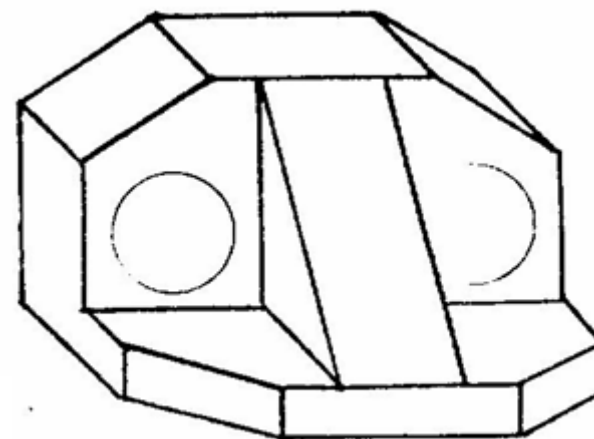
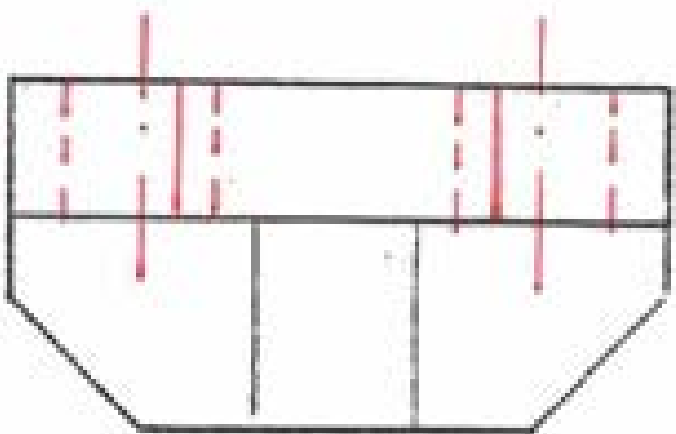
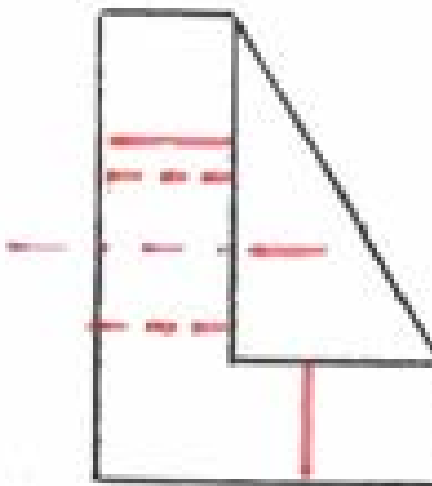
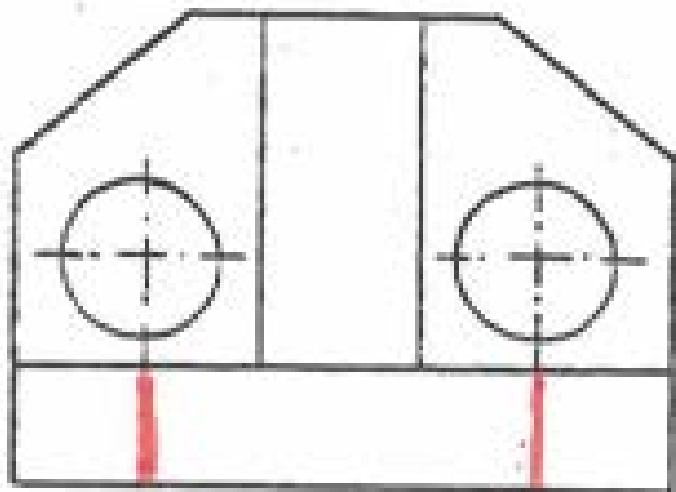
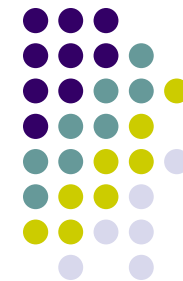

SLUT !

